



曾 泉 江 鐵 器 廠  
**CHAN CHUAN CHANG METAL WORKS**

BLOCK 5055, ANG MO KIO INDUSTRIAL PARK 2, #01-1141,  
SINGAPORE 569558 TEL : 64817736 FAX : 64813517  
Email: sales@ccc.com.sg Website: http://www.ccc.com.sg  
Reg. No. 204949/00M



# PLENUM BOX



**Brand : CCC**

**Air Diffusion Equipment**

**PLENUM BOX**

**Series : CCC-PB**

## CHAN CHUAN CHANG METAL WORKS



### VISION

“To produce high quality products, high standard of creativity in design and excellent credibility in reputation”

### MISSION

“Serve customer with satisfactory and reliable works and products”

Chan Chuan Chang Metal Works was established in 1975, committed to the vision to manufacture good quality Air Diffusion Equipment. After building up its reputation in the industry as a top manufacturer, the company registered the logo with the Registry of Trade and Patents (Singapore). From then onwards, all equipment which has the trade mark symbolise our commitment to serve our customer with satisfactory and reliable works and products.

Our products have been tested by VIPAC, testing laboratory at Victorian technology Centre, Port Melbourne, Victoria. Furthermore, the results are NATA Certified (National Association of Testing Authorities, Australia) to ADC 10623 R3 (Air Diffusion Council, USA) and are officially endorsed in countries which are signatories to the I.L.A.C agreement-namely, Australia, New Zealand, Britain, USA and Malaysia.

We were proud to introduce the **Heavy Duty Aluminium Computer Floor Grille**, Series : CR to the industry in 1991. This has been a breakthrough as the grille are able to provide adequate air flow whilst maintaining the weight of any person or equipment. This is verified by the Comprehensive Loading Test performed by Singapore Institute of Standard & Industrial Research (SISIR), currently known as Spring Singapore. Series : CR has since then been installed in many computer rooms, wafer manufacturing plant and places which require the product.



### COMPANY MILESTONE

**1975** Established with the vision to manufacture high quality Air Diffusion Equipment to meet future needs and demands. Together with a team of experienced Engineers & Craftsman dedicated to Chan Chuan Chang's Motto – Commitment, Creativity & Credibility, we produced good quality products with high standard of creativity in design and maintained excellent credibility in reputation.

**1982** Registered with the Registry of Trade and Patents (Singapore), CCC Trade Mark  has since become a household name in its industry.

**1986** Chan Chuan Chang (CCC) products are tested by VIPAC, a testing laboratory at Victorian Technology Centre, Port Melbourne, Victoria. These results are NATA Certified (National Association of Testing Authorities, Australia) to ADC 10623 R3 (Air Diffusion Council, USA) and are officially endorsed in countries which are signatories to the I.L.A.C agreement – namely, Australia, New Zealand, Britain, USA and Malaysia.

**1991** CCC Aluminium Computer Floor Air Grille was sent for Comprehensive Loading Test conducted by Singapore Institute of Standard & Industrial Research (SISIR) and achieved excellent results.

**1997** CCC was awarded ISO 9002 Certification. Our impressive list of satisfied clients is testimony to CCC's motto – Commitment, Creativity and Credibility.

**2005** CCC has improved its quality management system with respect to the ISO 9001:2000 standard due to our commitment towards quality improvement in our products and customer satisfaction. We thank you for your faith and support in our products. We will continue to strive harder to exceed your demand & satisfaction.

**2012** CCC was awarded ISO 9001:2008 Certification by BVQI Accreditation. CCC also became a certified member of Air Movement and Control Association International (AMCA). Our Low Leakage dampers were tested according to AMCA standards and received certifications.



## CCC-PB

### APPLICATIONS:

- Plenum Boxes can be used for both residential and commercial installations, and are used for both supply and return air.
- It is normally used for supply air applications for continuous Linear Bar Grilles, Linear Diffusers or Ceiling Diffusers.

### FEATURES:

- We do not have a standard size for plenum. These air diffusion equipment are custom fabricated specifically to your requirement.
- Different type of Plenum Boxes to suit your requirement. Choose between plain or insulated type upon request.
- Different type of round or oval shape neck collars to suit your ducting and area.

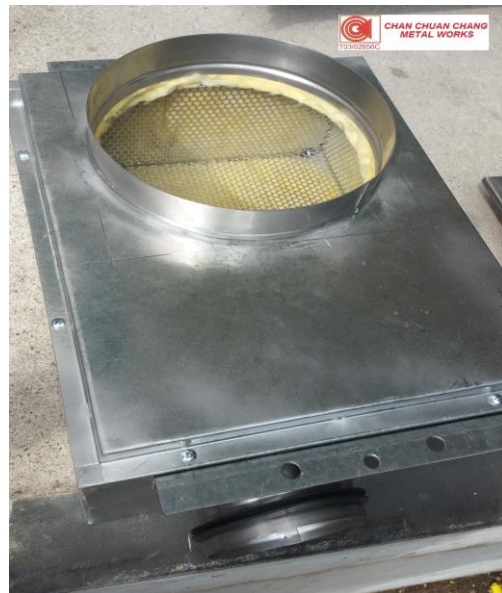



**Product Name :** Plenum Box

**Model :** CCC-PB

**Material :** E.G. / G.I. / SS304 / SS316

**Features :**

CCC Plenum Box is manufactured from high quality E.G. steel sheet construction with touch-up to welded areas. Our plenum boxes can be used for both supply and return air applications. The normal usage for Plenum Boxes are for Ceiling Diffusers, Single/Double-deflection grilles, Linear Bar Grilles, Linear Diffusers, Egg-Crate grilles etc. It is custom fabricated to meet your requirements, so please take note of the few optional points below.

**Points To Take Note When Ordering:**

- Black Tissue Insulation
- Fiberglass Insulation
- G.I. / SS304 / SS316 Perforated Sheet
- Neck Collar size & location
- Round or Oval Neck Collar

One Plenum Box may have 2 or 3 neck collars for ducting connections, so please take note of this. Please feel free to contact us anytime if there are any enquires.

**FEW EXAMPLES OF DIFFERENT TYPES OF PLENUM BOXES**

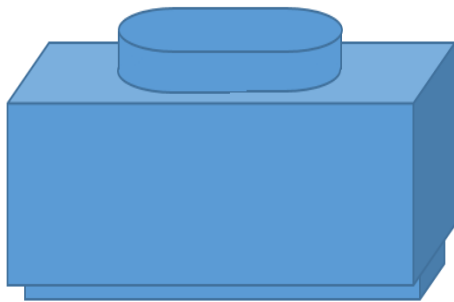

**Oval-Shaped Collar  
At Top**

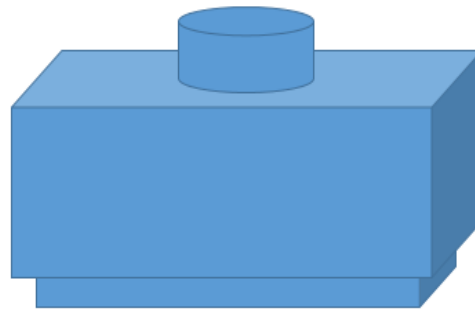

**Round Collar  
At Top**

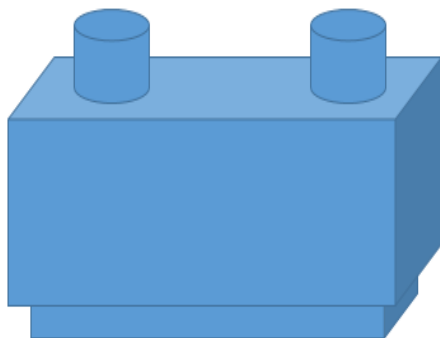

**Double Round Collar  
At Top**

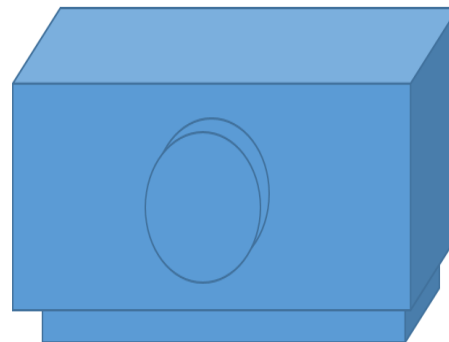

**Round Collar  
At Side**

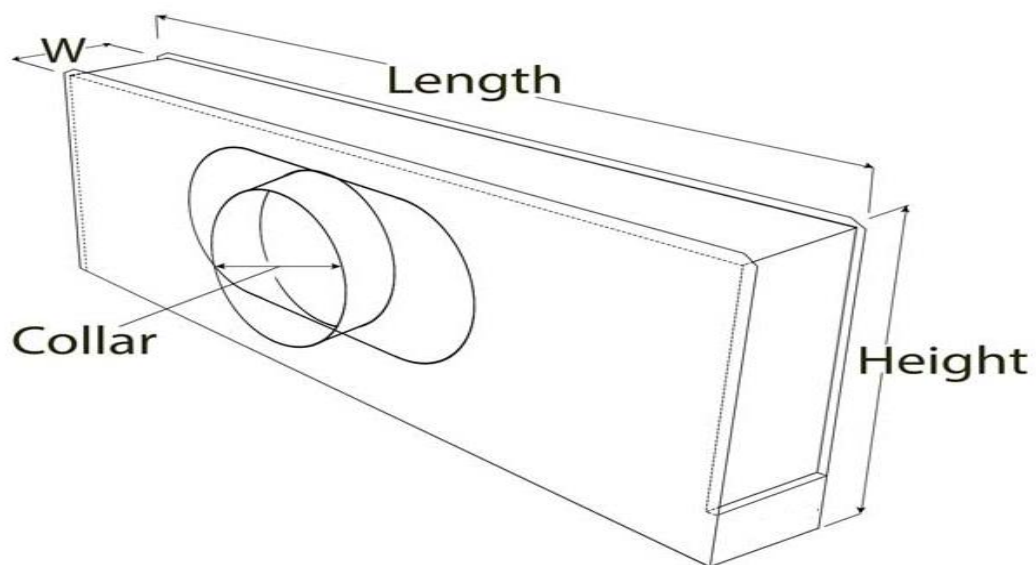

## OPTIONAL ITEMS FOR THE PLENUM BOXES



**Anti-Fire foam gaskets** for  
Your grilles to be installed.



**Volume Control Damper** as an  
Alternative option for the collar  
To control the airflow.

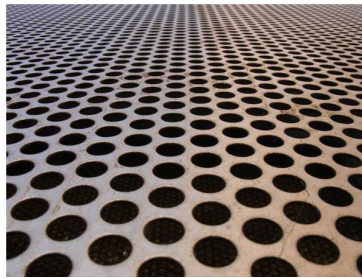

G.I. / SS304 / SS306 **Perforated  
Sheet** for your Plenum.

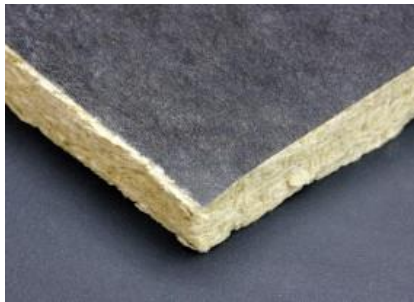

Standard 15mm **Black Tissue Insulation**  
Will be automatically used for most  
Of the Plenum.



**Fiberglass Insulation** of 48kg/m<sup>3</sup> with  
Thickness of 25mm to 50mm may be  
Available upon request.